

12
4

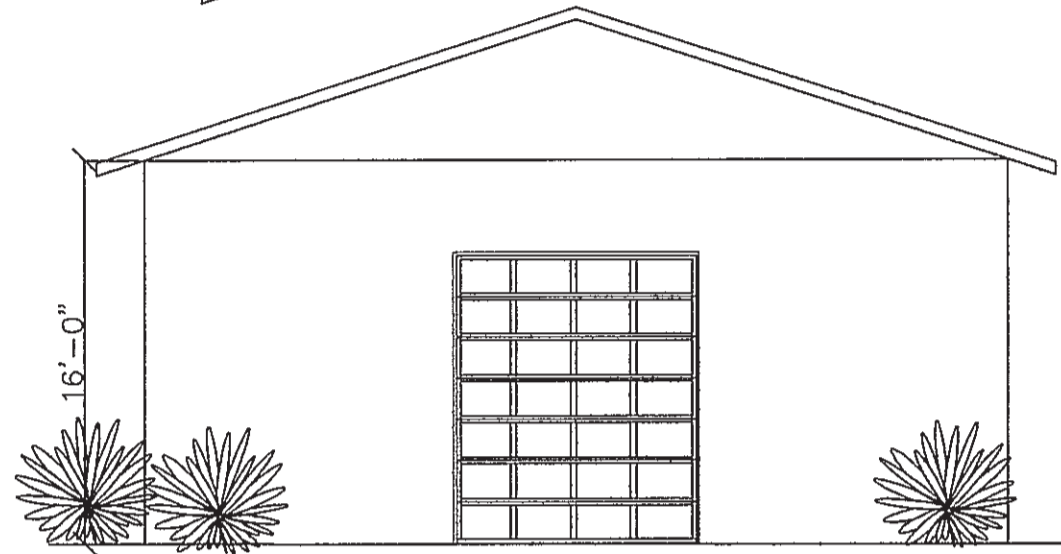

REAR ELEV.

SCALE ~ 1/8"=1'-0"

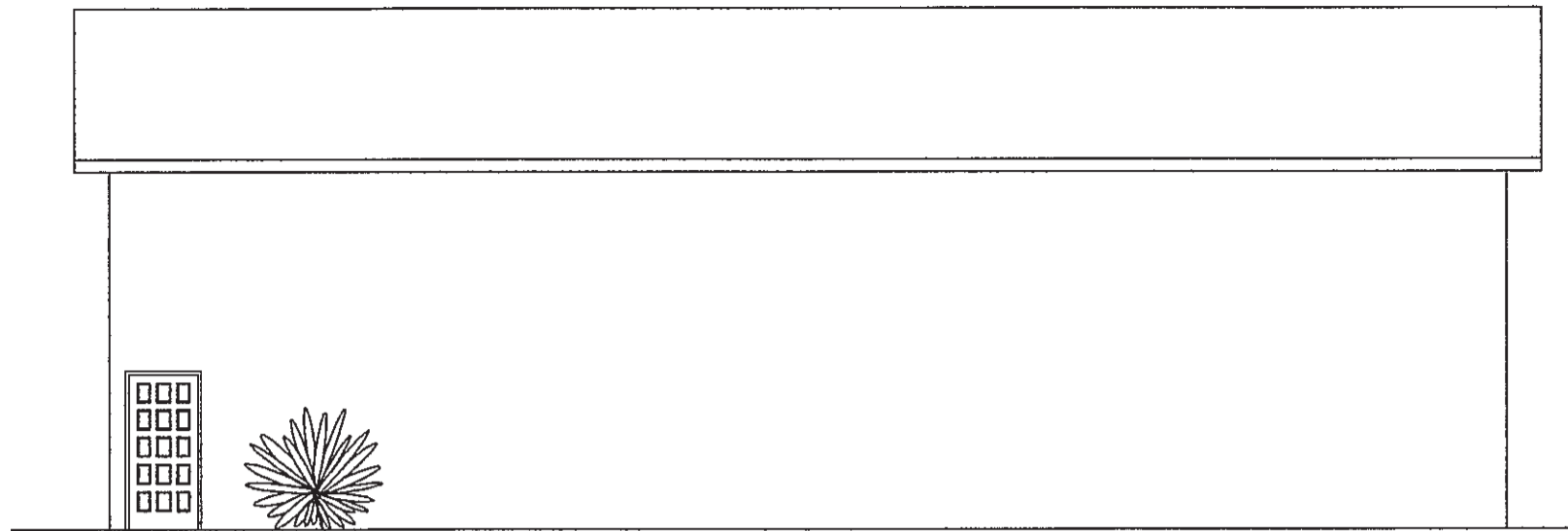

RIGHT ELEV.

SCALE ~ 1/8"=1'-0"

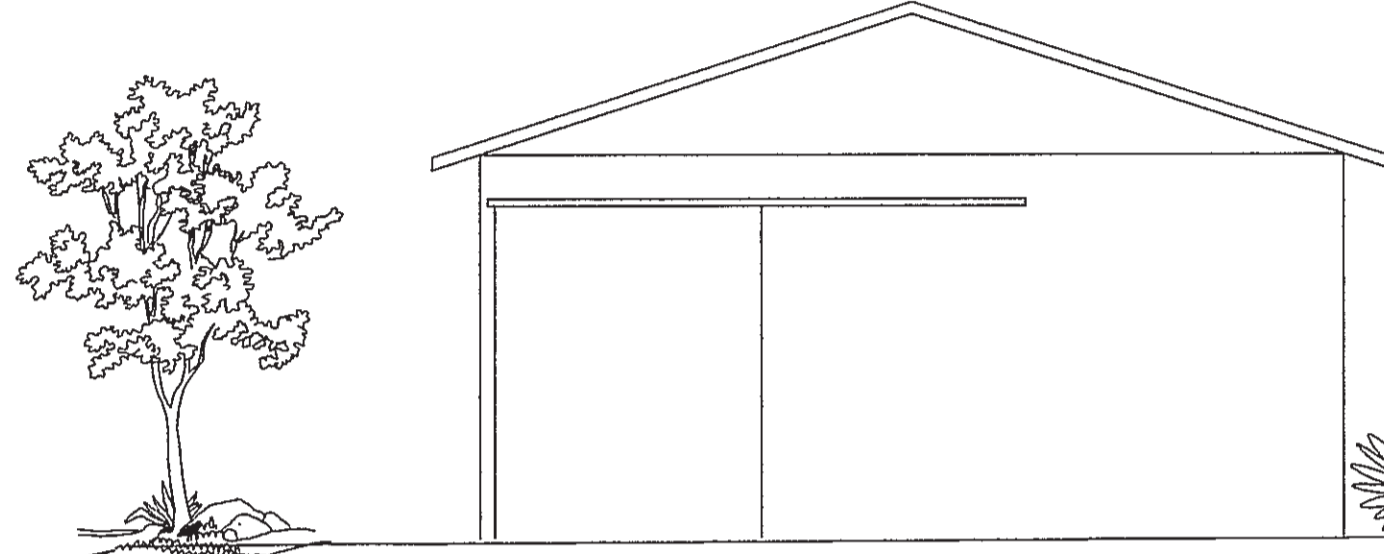

FRONT ELEV.

SCALE ~ 1/8"=1'-0"

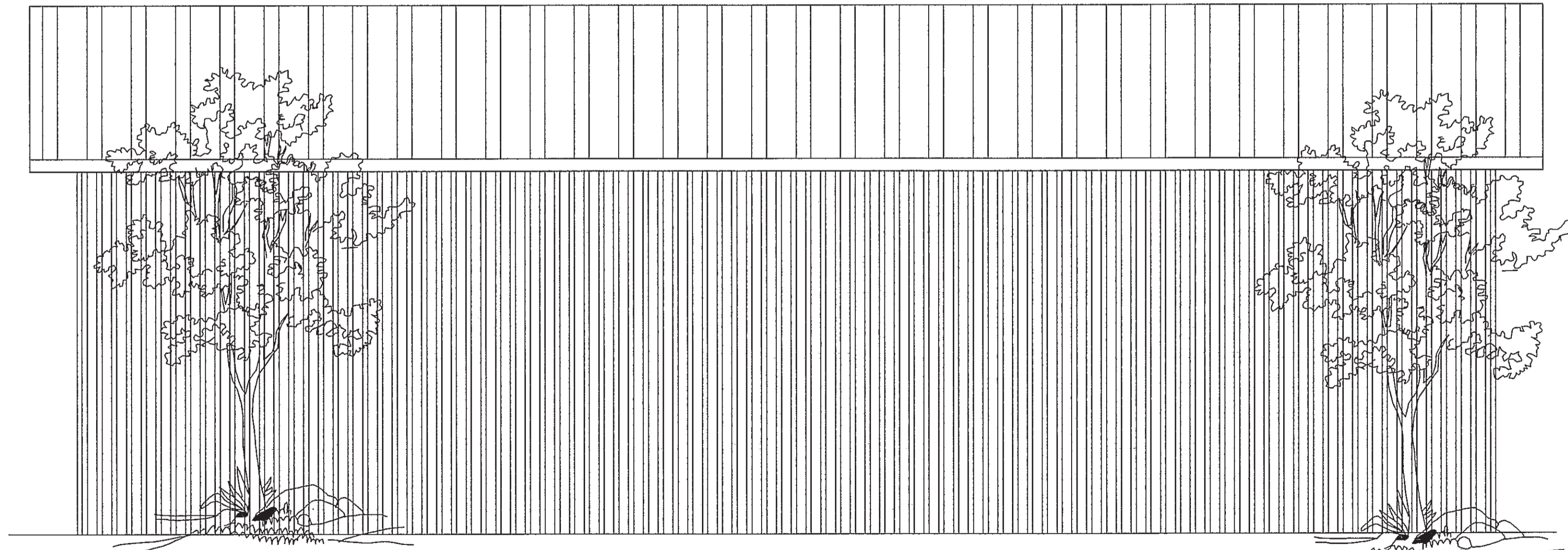

LEFT ELEV.

SCALE ~ 1/4"=1'-0"



Eatonville
388 Center St. E.
PH: 360.832.3424
FAX: 360.832.3454

Buckley
28280 HWY 410 E.
PH: 360.829.9049
FAX: 360.829.4174

Port Orchard
6100 Bethel Rd. E.
PH: 360.876.2903
FAX: 360.876.2924

Randle
105 Peters Cr. Rd.
PH: 360.497.3511
FAX: 360.497.7049

Orting
201 Calistoga St. W.
PH: 360.893.2200
FAX: 360.893.2303

Port Townsend
8457 SR 20
PH: 360.385.9474
FAX: 360.379.2872

Plan
3660PB16

SHEET 1
OF 2 SHTS

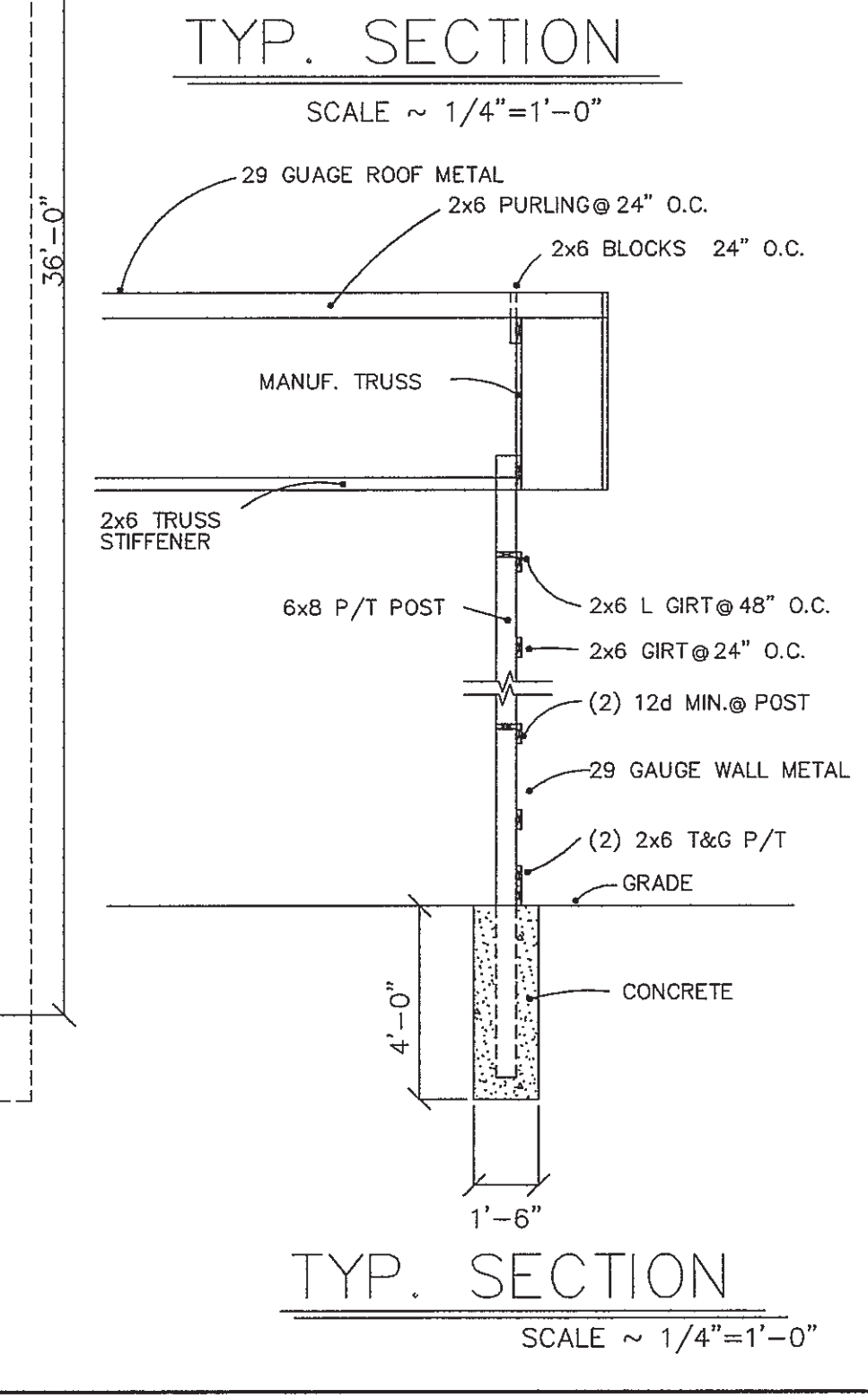
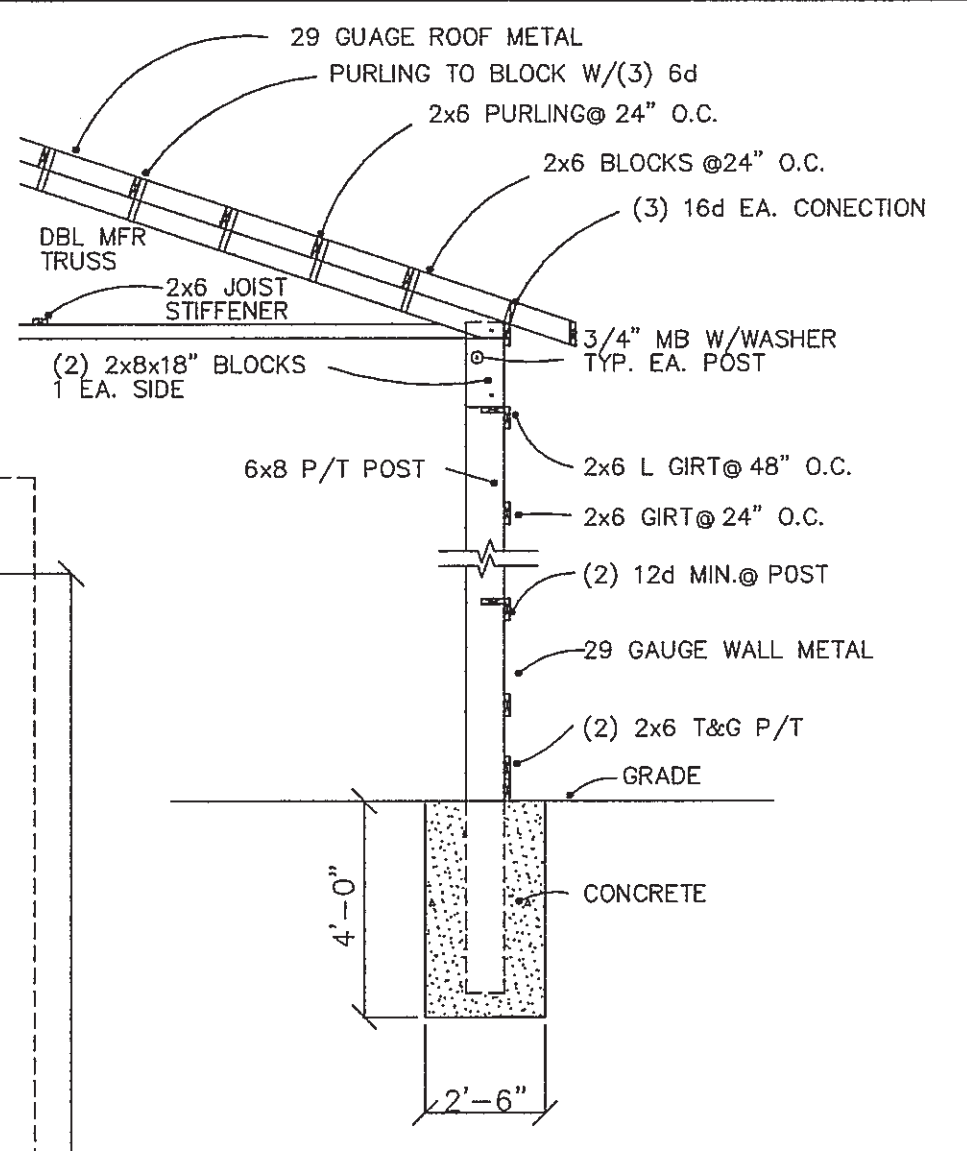
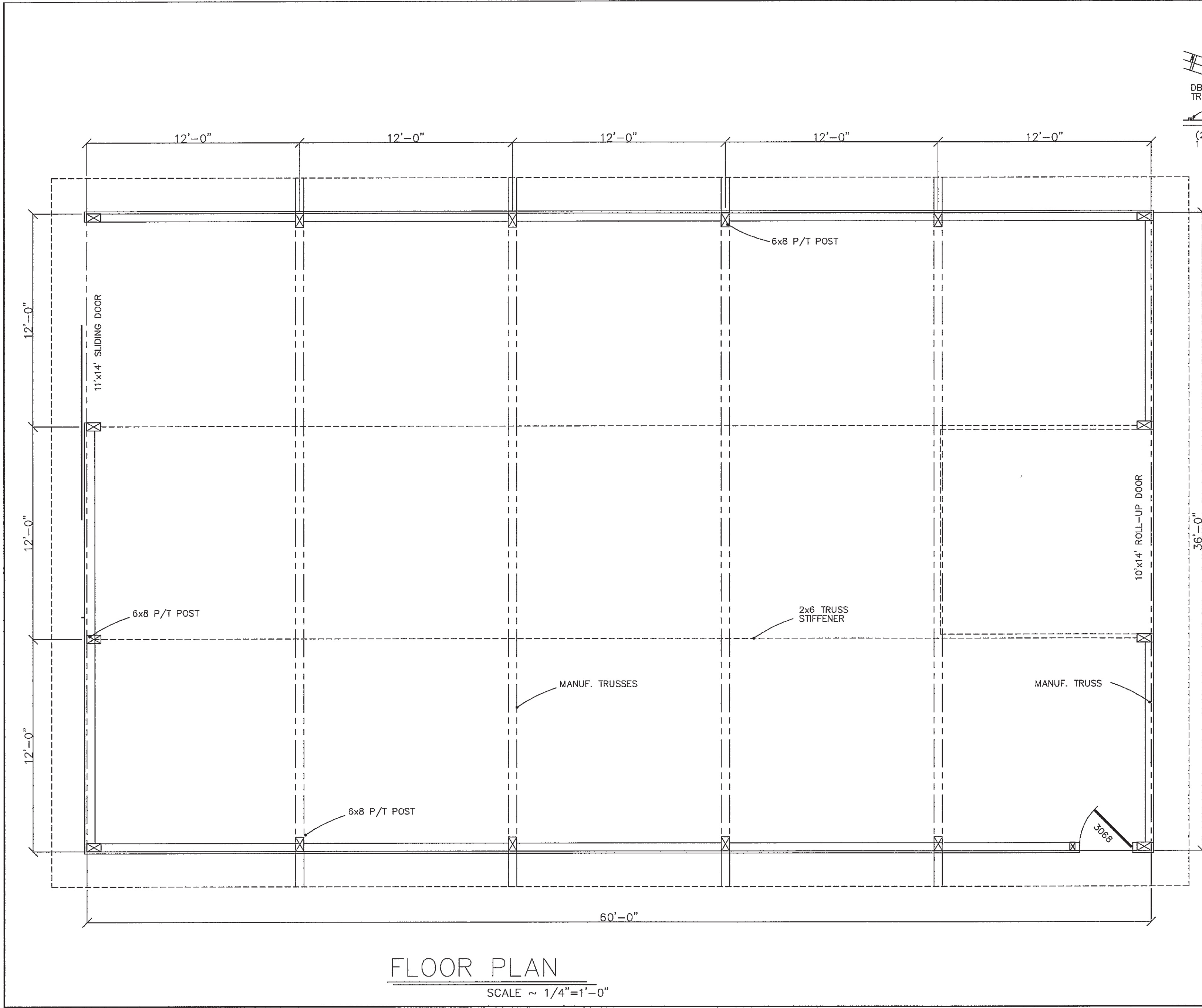

Eatonville 388 Center St. E. PH: 360.832.3424 FAX: 360.832.3454	Buckley 28280 HWY 410 E. PH: 360.829.9049 FAX: 360.829.4174	Port Orchard 6100 Bethel Rd. E. PH: 360.876.2903 FAX: 360.876.2924	Randle 105 Peters Cr. Rd. PH: 360.497.3511 FAX: 360.497.7049	Orting 201 Calistoga St. W. PH: 360.893.2200 FAX: 360.893.2303	Port Townsend 8457 SR 20 PH: 360.385.9474 FAX: 360.379.2872
---	---	--	--	--	---

Plan
3660PB16

SHEET **2**
OF **2** SHTS